

ASG Ø700

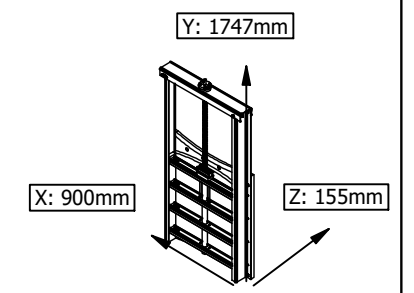

Back view

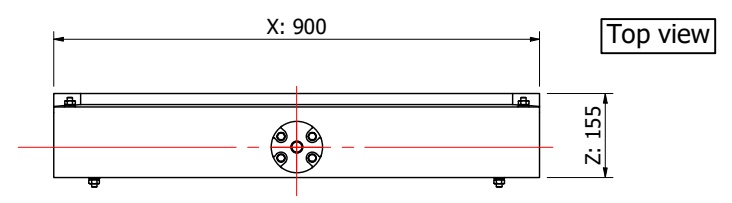
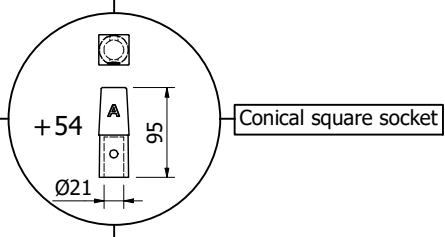
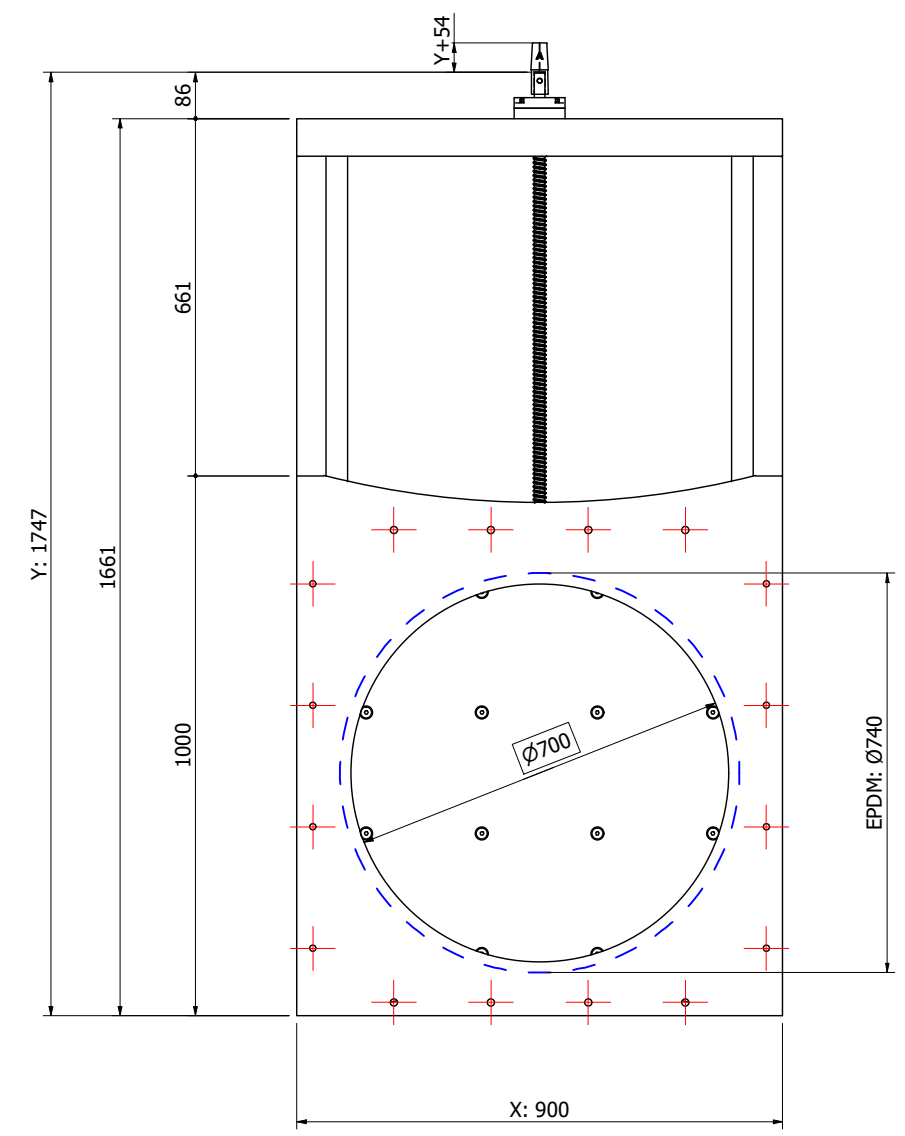

Front view

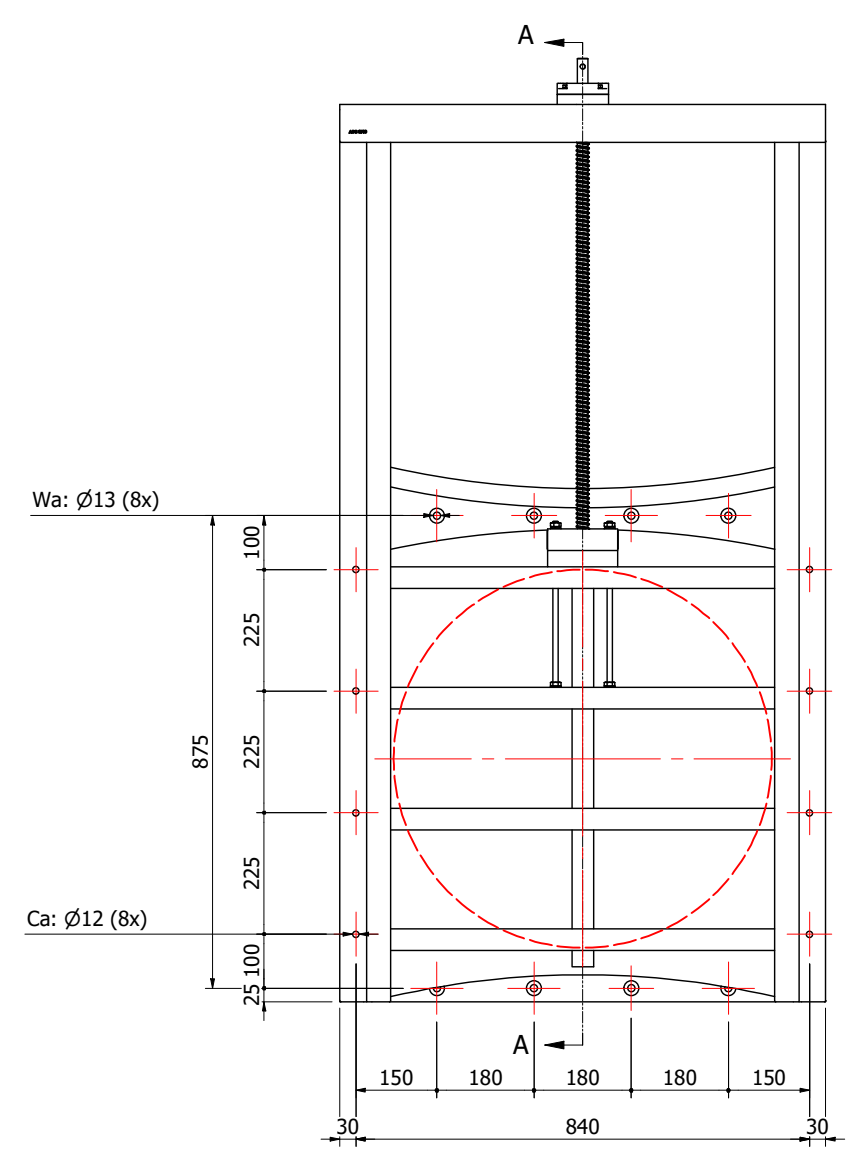

Section view A-A

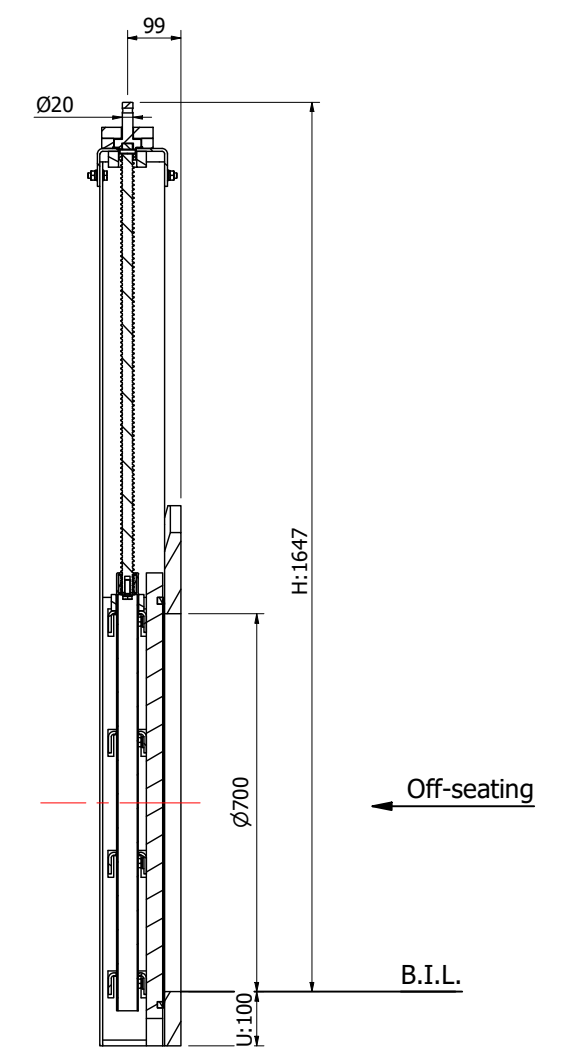

ASG-G HDPE/SS316 Penstock Specification

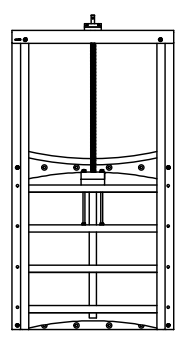

Opening: Ø700mm
 Standard supplied with a non-rising spindle.
 It has an HDPE back plate.
 EPDM lip seal between door and frame plate.
 Supplied with neoprene seal between wall and frame plate.
 Door made from HDPE and large penstocks will be reinforced with SS316 U-profiels.

Materials used; HDPE, SS316, EPDM, POM, Neoprene.
 Max. load (on/off seating):
 5 MWC from bottom invert level (B.I.L.)
 Bare shaft: Ø20mm
 All dimensions in mm

Please refer to our installation manual for more detailed information regarding mounting

Ca = Chemical anchors (incl. capsule)
 (8x) M10x165 - A4

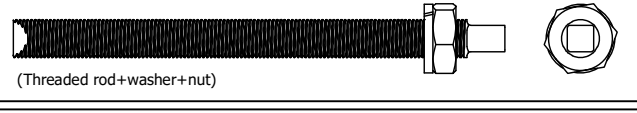

Wa = Wedge anchors
 (8x) M10x60 - A4

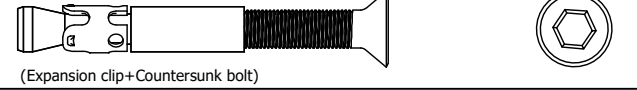

Signed for agreement: Name: Date:.....

The stated sizes are approximate. We advise you to measure the materials immediately after delivery before you proceed to installation!
 Copyright: This drawing remains property of Aquafix Milieu B.V. Nothing of this may be reproduced or multiplied without the permission of Aquafix Milieu B.V.

AQUAFIX MILIEU
 Postbus 288 3640 AG Mijdrecht
 T: +31 (0)297 - 26 29 29
 F: +31 (0)297 - 26 12 72
 E: info@aquafix.nl
 W: www.aquafix.nl

Penstock ASG Ø700 - HDPE/SS316		Rev.:1
Model: Wallmount (G) - Non-rising spindle		
Artikelnr.: 670ASG0700G		
		± 98 kg.
Get.: GC	Datum: 07-08-2020	Schaal: 1:14
		Formaat: A3
		Tek. nr.: ASG1900150
		Blad: 10